



Next Gen MXR 7380

Powered by Bosch® for best performance

New product, new solutions



Enhance durability & service life

Patented continuous wave laser welded electrodes enhance durability and service life.

Core design features taken over from Bosch® 7305 / 7308 for maximum reliability and increased service life.

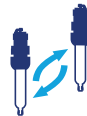

Drop-in replacement

Drop-in replacement for 7305/7308, 18GZ5-77-2, GL3-5. No adjustments needed.



High reliability

Best in class ceramic with high di-electric strength
High quality composite ceramic resistor from 7305/7308.



New design

High performance triple Ir. industrial spark plug.

Extended service life

Up to 30% Better than competitors

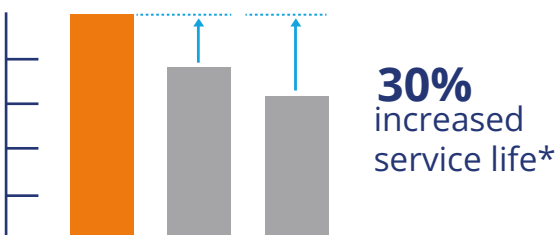

* Results based on field experiences. 30% increased service life has been established in some instances.
Note: lifetime depends on operation conditions including but not limited to fuel, duty cycle/load, ignition system, and environmental conditions.

MXR 7380 spark plug is co-developed and produced under license with Robert Bosch GmbH, Germany



H2-ready spark plug

Completely new foot design decreases heat range and makes plug H2-ready.

For all gas-markets

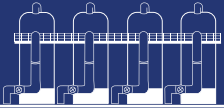

NATURAL-GAS

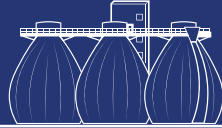

SEWAGE-GAS

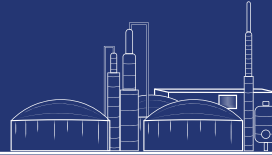

BIO-GAS

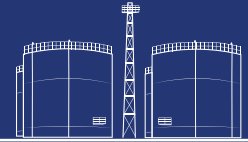

H2-ready

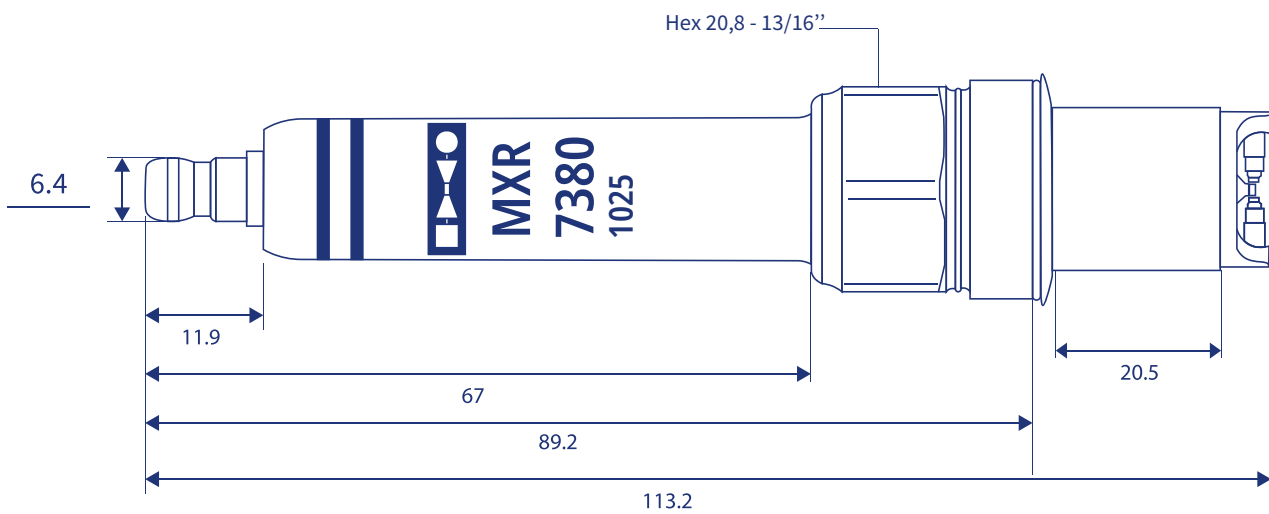

Applicable for various engines like;

- MAN® E2842, E3262 and E3268
- Deutz® / MWM® TBG616 and TBG620
- Cummins® QSV91 and QSK60
- Guascor® FGLD series and SFGLD series
- CAT® 3500 A/B versions and 3600 series
- Perkins® 4000 series- TESI
- Waukesha® L7044GSI and more...



Cross references:

BOSCH 7305 / 7308

MR 3 DII 360

DENSO

GI3-5 / GL3-5

FEDERAL MOGUL / BERU

18GZ6-77-2/18GZ5-77-2

CHAMPION

FB77WPCC / RB75WPCC

GUASCOR

: 76.64.292

MAN

: 51.25923-0059